

Programmable Power Supply

PPE-1323/3323

USER MANUAL

GW INSTEK PART NO. 82PE-3323oMD



ISO-9001 CERTIFIED MANUFACTURER

GW INSTEK

TABLE OF CONTENTS

| | Page |
|--|------|
| 1. Precautions..... | 1 |
| 2. Description..... | 6 |
| 3. Features..... | 7 |
| 4. Specifications..... | 8 |
| 5. Front Panel and Rear Panel..... | 11 |
| 5.1. Front Panel..... | 11 |
| 5.2. Rear Panel..... | 17 |
| 6. Operating Instructions..... | 18 |
| 6.1 Output Voltage / Current Setting..... | 18 |
| 6.2 Over Voltage / Over Current Protection Setting..... | 19 |
| 6.3 Voltage / Current Step Setting..... | 20 |
| 6.4 Data Storage and Recall Setting..... | 21 |
| 6.5 Automatic Execution..... | 22 |
| 6.6 Serial Mode Operation (PPE-3323 only)..... | 23 |
| 6.7 Track Mode Operation (PPE-3323 only)..... | 23 |
| 6.8 3.3V / 5V Output (PPE-3323 only)..... | 24 |
| 6.9 PPE-1323/3323 Maximum Output Setting..... | 24 |
| 7. Communication Interface..... | 25 |
| 7.1 Operating with the Serial Transmission Commands :..... | 25 |
| 7.2 Table of Error Messages..... | 27 |
| 7.3 RS-232C Serial Interface Commands..... | 28 |
| 7.4 System Status..... | 32 |
| 7.5 Programming of PPE-1323 / 3323..... | 34 |
| 8. Adjustment and Calibration..... | 36 |
| 9. The System Diagram and Description..... | 47 |

EC Declaration of Conformity

We

GOOD WILL INSTRUMENT CO., LTD.

No. 7-1, Jhongsing Rd., Tucheng City, Taipei County 236, Taiwan

GOOD WILL INSTRUMENT (SUZHOU) CO., LTD.

No. 69 Lushan Road, Suzhou New District Jiangsu, China.

declare that the below mentioned product

PPE-1323, PPE-3323

are herewith confirmed to comply with the requirements set out in the Council Directive on the Approximation of the Law of Member States relating to Electromagnetic Compatibility (89/336/EEC, 92/31/EEC, 93/68/EEC) and Low Voltage Equipment Directive (73/23/EEC, 93/68/EEC).

For the evaluation regarding the Electromagnetic Compatibility and Low Voltage Equipment Directive, the following standards were applied:

| EN 61326-1:Electrical equipment for measurement, control and laboratory use—EMC requirements (1997+A1:1998) | | | | |
|--|-------------------------|-------|--------------------------------|----------------------|
| Conducted Emission | EN 55022 class B (1994) | | Electrostatic Discharge | IEC 1000-4-2 (1995) |
| Radiated Emission | EN 55011 class B (1991) | | Radiated Immunity | IEC 1000-4-3 (1995) |
| Current Harmonics | EN 61000-3-2 (1995) | | Electrical Fast Transients | IEC 1000-4-4 (1995) |
| Voltage Fluctuations | EN 61000-3-3 (1995) | | Surge Immunity | IEC 1000-4-5 (1995) |
| ----- | ----- | ----- | Conducted Susceptibility | EN 61000-4-6 (1996) |
| ----- | ----- | ----- | Power Frequency Magnetic field | EN 61000-4-8 (1993) |
| ----- | ----- | ----- | Voltage Dip/Interruption | EN 61000-4-11 (1994) |
| Low Voltage Equipment Directive 73/23/EEC & amended by 93/68/EEC | | | | |
| Safety Requirement | | | IEC/EN 61010-1: 2001 | |

1. Precautions

PPE-1323/3323 is especially designed for safe operation. It has passed rigorous tests of inclement environment to ensure its reliability and good condition.

The following precautions are recommended to ensure your safety and the best condition of this equipment.

(1) Safety Terms and Symbols

The following terms and symbols may appear in this manual:



WARNING

This statement identifies conditions or practices that could result in injury or loss of life.



CAUTION

This statements identifies conditions or practices that could result in damage to this product or other properties.

The following terms and symbols may appear on the product:

DANGER

This term indicates an immediately accessible injury hazard.

WARNING

This term indicates that an injury hazard may occur, but is not immediately accessible.

CAUTION

This term indicates potential damage to this product or other properties.



Danger
high voltage



Protective
conductor
terminal



Attention
refer to manual



Double
insulation



Danger
hot surface



Equipotentiality

(2) Do not place any heavy objects on the instrument under any circumstances.

(3) Disassembling the instrument

Due to the precision of this instrument, all the disassembly, adjustment, and maintenance should be performed by a professional technician. If the instrument have to be opened or adjusted under some unavoidable conditions, it should be carried out by a technician who is familiar with PPE-1323/3323. Once there is any abnormality, please contact our company or the agency near you.

(4) Power Supply

AC input should be within the range of line voltage $\pm 10\%$, 50/60Hz. To prevent the instrument from burning up, be sure to check the line voltage before turning on power.

(5) Grounding



WARNING

To avoid electrical shock, the power cord protective grounding conductor must be connected to ground.

PPE-1323/3323 can only operate with a earth grounded AC power cord that connects the case and ground well. This is to protect the user and the instrument from the risk of shock hazard.

(6) Fuse Replacement



WARNING

For continued fire protection, replace fuse only with the specified type and rating. Disconnect the power cord before replacing fuse.

The fuse blows only if anything wrong with the instrument. Please check and replace a proper fuse as listed below. Be sure to use the correct fuse before apply the voltage.

PPE-1323

90V ~ 132V : T 3.15A / 250V

198V ~ 250V : T 1.6A / 250V

PPE3323

90V ~ 132V : T 6.3A / 250V

198V ~ 250V : T 3.15A / 250V

(7) Cleaning the Cabinet

Always disconnect the AC power cord before cleaning the instrument.

Use a soft cloth dampened in a solution of mild detergent and water. Do not spray cleaner directly into the instrument, since it may leak into the cabinet and cause damage.

Do not use chemicals containing benzine, benzene, toluene, xylene, acetone, or similar solvents.

(8) Operating environment

Indoor use

Altitude up to 2000m

Temperature to satisfy the specification : 18°C ~ 28°C (+64.4°F ~ +82.4°F)

Operating temperature : 0°C ~ 40°C (+32°F ~ +104°F)

Storage temperature : -10°C ~ 70°C (+14°F ~ 158°F)

Relative humidity : up to 90% when 0°C~35°C;
up to 70% when 35°C~50°C

Installation category : II

Pollution degree : 2

(9) Place PPE-1323/3323 in a location that satisfies the conditions stated above, and is free from dust, direct exposition of sunlight, and strong effect of magnetic fields.

(10) For United Kingdom

NOTE

This lead/appliance must only be wired by competent persons.

WARNING

THIS APPLIANCE MUST BE EARTHED

IMPORTANT

The wires in this lead are colored in accordance with the following codes:

Green/Yellow :Earth
Blue :Neutral
Brown :Live
(Phase)

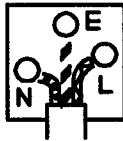

As the colors of the wires in mains leads may not correspond with the colored markings identified in your plug/appliance, proceed as follows:

The wire which is colored Green and Yellow must be connected to the Earth terminal marked with the letter E or by the earth symbol \oplus or colored Green or Green and Yellow.

The wire which is colored Blue must be connected to the terminal which is marked with the letter N or colored Blue or Black.

The wire which is colored Brown must be connected to the terminal marked with the letter L or P or colored Brown or Red.

If in doubt, consult the instructions provided with the equipment or contact the supplier.

This cable/appliance should be protected by a suitably rated and approved HBC mains fuse; refer to the rating information on the equipment and/or user instructions for details. As a guide, cable of 0.75mm^2 should be protected by a 3A or 5A fuse. Larger conductors would normally require 13A types, depending on the connection method used.

Any moduled mains connector that requires removal/replacement must be destroyed by removal of any fuse and fuse carrier and disposed of immediately, as a plug with bared wires is hazardous if engaged in a live socket. Any re-wiring must be carried out in accordance with the information detailed in this section.

2 . Description

- PPE-1323/3323 are programmable power supplies with microprocessor (MPU) controlled circuits and RS-232 interfaces. They can totally meet your demands on auto-test and auto-control.
- The voltage and current are controlled by a 12-bit D/A CONVERTER, and their resolutions can be as high as 10mV and 1mA respectively.
- The digitized system enables you to input all the data via keyboard with speed and convenience.
- The voltage/current are automatically calibrated by software to increase the accuracy of the instrument.
- The protections against Over voltage (OVP) and Over current (OCP) are completely set by software to ensure the safety of users and instrument.

3. Features

- Easy operation
- High resolution ~ voltage resolution :10mV; current resolution :1mA
- Digital panel types : voltage / current 4 digits
- High stability with less drift
- Protection against Over voltage (OVP) , Over current (OCP) , and Over load (OLP)
- Memory of data base : 100 sets (PPE-1323) , 50 sets (PPE-3323)
- Automatic calibration complete set by software
- Self-test with the displaying of error messages
- Operate automatically according to the preset time
- RS-232C interface (option)
- sets of output (PPE-3323 ONLY)
- Operation modes : Serial , Track (PPE-3323 ONLY)
- Conform to the safety standards of UL, CSA , CE, LVDetc.

4. Specifications

| ITEM | MODEL | PPE-3323 | | | |
|--|---------|--|-----------|----------|-----------------|
| | | PPE-1323 | PPE-3323 | | |
| OUTPUT | Voltage | 0 ~ 32V | 0 ~ -32V, | 0 ~ 32V, | 3.3V / 5V Fixed |
| | Current | 0 ~ 3A | 0 ~ -3A, | 0 ~ 3A, | 3A Fixed |
| | OVP | 0 ~ 33V | 0 ~ -33V, | 0 ~ 33V, | OLP |
| LOAD EFFECT | Voltage | ≤ 6mV | | | |
| | Current | ≤ 3mA | | | |
| SOURCE EFFECT | Voltage | ≤ 3mV | | | |
| | Current | ≤ 3mA | | | |
| RESOLUTION | Voltage | 10mV | | | |
| | Current | 1mA | | | |
| | OVP | 10mV | | | |
| PROGRAM ACCURACY (25 ± 5 °C) | Voltage | ≤ 0.05% + 25mV | | | |
| | Current | ≤ 0.2 % + 10mA | | | |
| | OVP | ≤ 2 % + 0.6V | | | |
| RIPPLE & NOISE (20Hz ~ 20MHz) | Voltage | Ripple ≤ 1mVrms / 3mVp-p Noise ≤ 2mVrms / 30mVp-p | | | |
| | Current | ≤ 3mArms | | | |
| TEMPERATURE COEFFICIENT (0~40 °C) | Voltage | ≤ 100ppm + 3mV | | | |
| | Current | ≤ 150ppm + 3mA | | | |
| READBACK RESOLUTION | Voltage | 10mV | | | |
| | Current | 1mA | | | |
| ACCURACY (25±5 °C) | Voltage | ≤ 0.05% + 25mV | | | |
| | Current | ≤ 0.2 % + 10mA | | | |

| ITEM | MODEL | PPE-1323 | PPE-3323 |
|--|--|-------------------------|-------------------------|
| | RESPONSE TIME | | |
| VOLTAGE UP | 10~90% | ≤ 100mS | |
| VOLTAGE DOWN | 90~10% | ≤ 100mS | |
| READBACK TEMPERATURE COEFFICIENT | Voltage | ≤ 100ppm + 10mV | |
| | Current | ≤ 150ppm + 10mA | |
| DRIFT | Voltage | ≤ 100ppm + 10mV | |
| | Current | ≤ 150ppm + 10mA | |
| TRACK OPERATION | Tracking Error | ≤ 0.1% + 50mV | (for PPE-3323) |
| MEMORY | Store / Recall Point | 0 ~ 99 | (0 ~ 49 for PPE-3323) |
| TIMER | Setting time | 1 sec ~ 99 Min. | |
| | Resolution | 1 sec | |
| | Function | for output working loop | |
| 3.3V / 5V FIXED OUTPUT (for PPE-3323) | Regulation | Line regulation | ≤ 5 mV |
| | | Load regulation | ≤ 10mV |
| | Ripple & Noise | ≤ 2mVrms | |
| | Voltage Accuracy | 3.3V ± 0.16V, | 5V ± 0.25V |
| | Output Current | 3A | |
| | Overload Protection Current | > 3A | |
| TEMPERATURE | Operating | 0 °C ~ 40 °C, | Storage -10 °C ~ 70 °C |
| POWER SOURCE | AC 100V, 120V, 220V, 240V, ± 10% 50/60Hz | | |
| DIMENSIONS | 255(W) × 145(H) × 346(D) mm | | |
| WEIGHT | PPE-1323 | : Approx. | 9.5Kg |
| | PPE-3323 | : Approx. | 10Kg |

5. Front Panel and Rear Panel

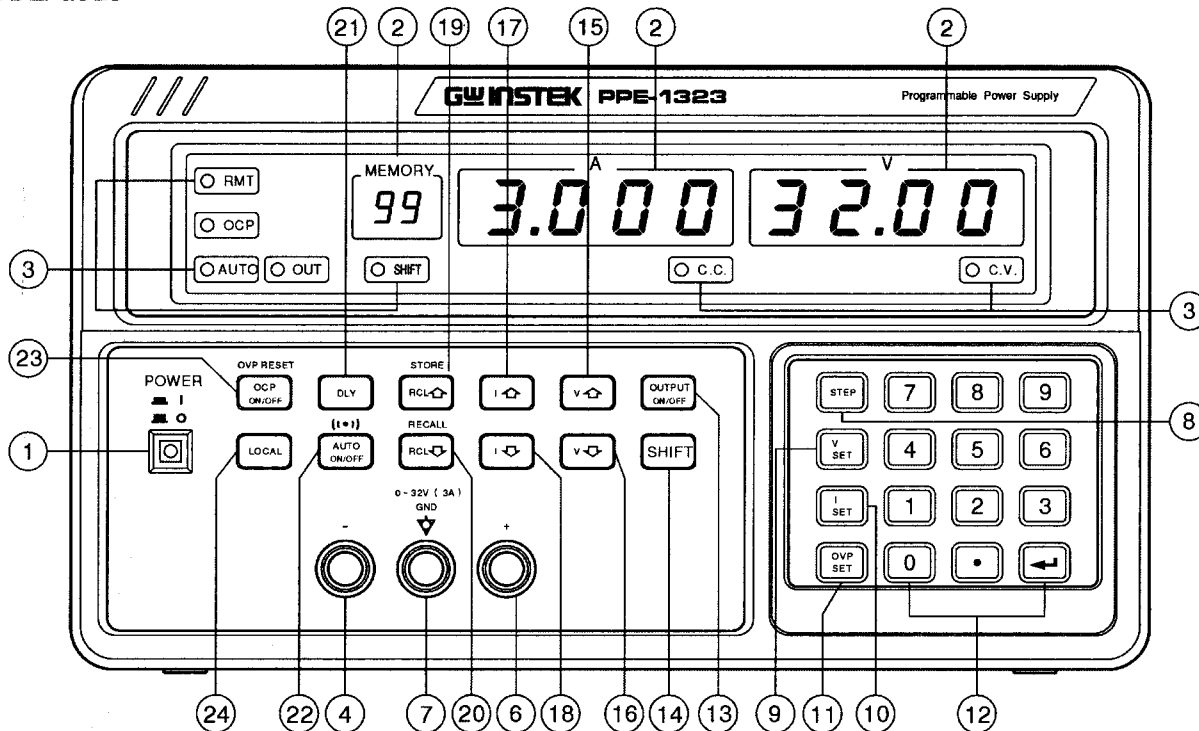

5-1. Front Panel

PPE-1323

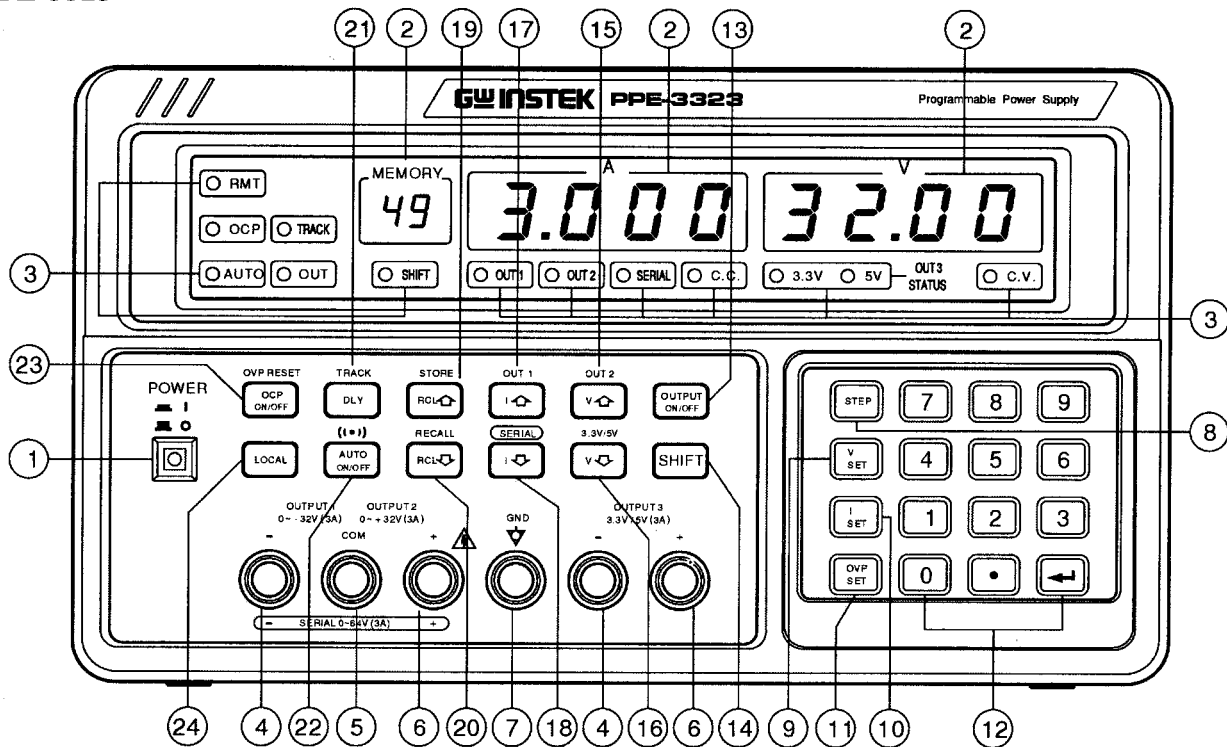

PPE-3323



- ① **Power button** : "  " -- power is on; "  " -- power is off
- ② **Value displays** : V display : Indicates the testing or setting voltage
A display : Indicates the testing or setting current
MEMORY : Indicates the present data's location in memory
- ③ **Status display** : Indicates the operation state of the instrument
- ④ **- Output terminal** : negative output terminal
- ⑤ **COM terminal** : positive / negative output reference
- ⑥ **+Output terminal** : positive output terminal
- ⑦ **GND terminal** : Ground terminal, which connects to the CASE
- ⑧ **STEP** : Set step voltage / current
- ⑨ **V SET** : Set output voltage
- ⑩ **I SET** : Set output current
- ⑪ **OVP SET** : Set the limit of over voltage
- ⑫ **0 ~ 9** : Data input
- " . " : a decimal point
- "  " : To execute
- ⑬ **OUTPUT ON/OFF** : Push once to turn on output function; push once more to turn off the function
- ⑭ **SHIFT** : To shift and proceed secondary functions
- ⑮ **V \uparrow (OUT 2)** : V \uparrow : Output the voltage of one step up
OUT 2 : Push [SHIFT] [OUT 2] to change to OUTPUT 2

- ⑩ **V↓ (3.3V/5V)** : V↓ : Output the voltage of one step down
3.3V/5V : Push [SHIFT] [3.3V/5V], to make the output of OUT 3 to be 3.3V or 5V
- ⑪ **I↑ (OUT 1)** : I↑ : Output the current of one step up
OUT 1 : Push [SHIFT] [OUT 1] to change to OUTPUT 1
- ⑫ **I↓ (SERIAL)** : I↓ : Output the current of one step down
SERIAL : Push [SHIFT] [SERIAL] to make the instrument working in serial mode
- ⑬ **RCL↑ (STORE)** : RCL↑ : To recall the last stored data
STORE : Push [SHIFT] [STORE] to save the data in memory
- ⑭ **RCL↓ (RECALL)** : RCL↓ : To recall the next stored data
RECALL : Push [SHIFT] [RECALL] to recall the data stored in the specified position or the make the instrument to perform setting automatically
- ⑮ **DLY (TRACK)** : DLY : Set the output time of voltage/current
TRACK : Push [SHIFT] [TRACK] to make the instrument working in TRACK mode
- ⑯ **AUTO ON/OFF** : Push once to turn on the auto-execution function; push once more to turn off this function
- ⑰ **OCP ON/ OFF (OVP RESET)** : OCP ON/OFF : Turn on or turn off the over current protecting function
OVP RESET : Push [SHIFT] [OVP RESET] to turn off the over voltage protection mode
- ⑱ **LOCAL** : To turn off the REMOTE control function, the user has to operate via panel in this situation

PPE-1323

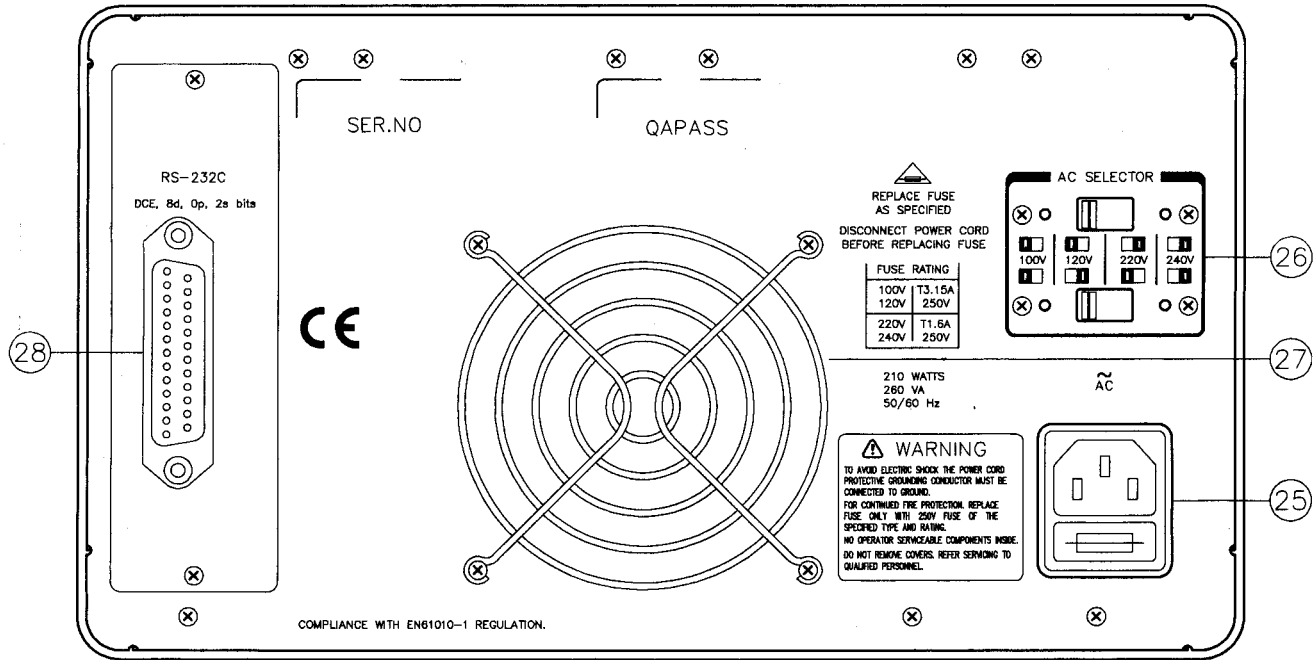

PPE-3323

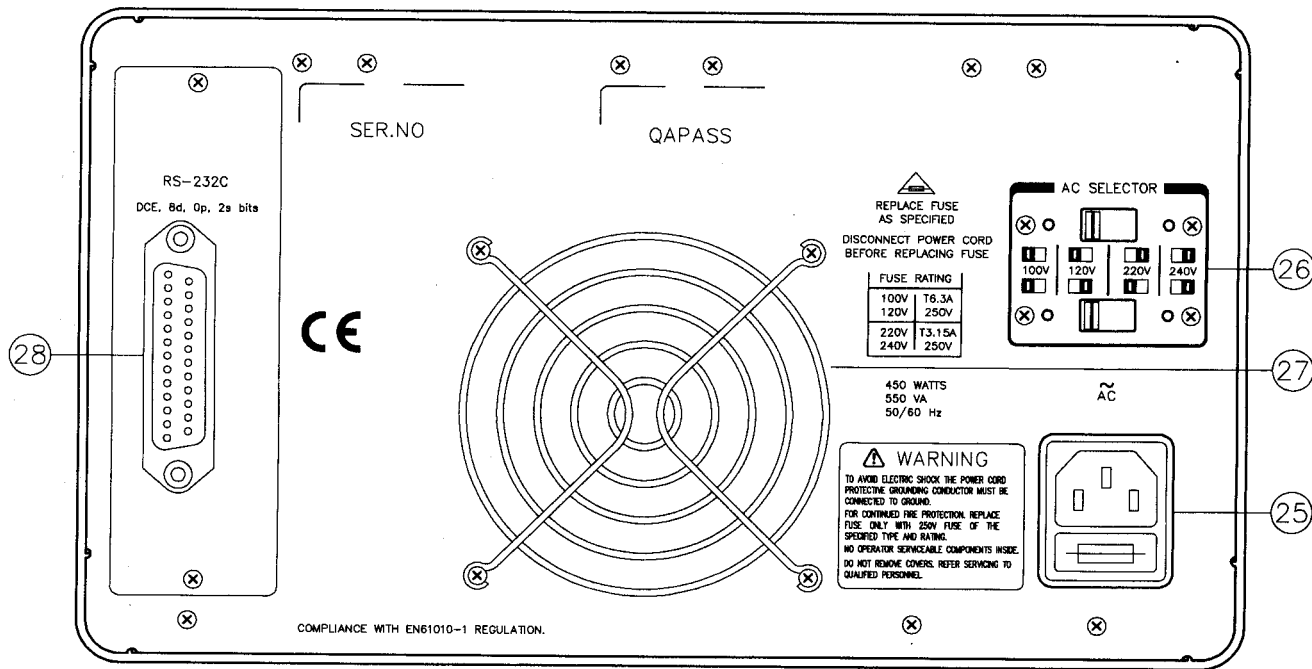

5.2. Rear Panel

- ②5 **AC power socket**
- ②6 **Applying voltage selector :** The switches to select the input voltage among 100V, 120V, 220V or 240V (50 / 60 HZ)
- ②7 **Cooling fan**
- ②8 **RS-232C interface**

6. Operating Instructions

6.1 Output Voltage / Current Setting

- **Output voltage setting**

Push [V SET] [Number keys] [↵] keys to set output voltage.

Example : to set the output voltage to 32.00V.

Push [V SET] [3] [2] [.] [0] [0] [↵].

- **Output current setting**

Push [I SET] [Number keys] [↵] keys to set output current.

Example : to set output current to 3.000A.

Push [I SET] [3] [.] [0] [0] [0] [↵].

When the output current is overloaded, it automatically switches to the constant current mode (C.C. Mode); while output current is within the set value, it operates in constant voltage mode (C.V. Mode).

6.2 Over Voltage / Over Current Protection Setting

- **Over Voltage Protection Setting**

Push [OVP SET] [Number keys] [↵] keys to set OVP voltage level.

Example : Set the OVP voltage to 33.00V.

Push [OVP SET][3] [3] [.] [0] [0] [↵].

- **Clear OVP status**

When the output voltage exceeds the OVP setting 33.00V, the output will be off, the instrument will get into the OVP mode, and "OVP Err" will be shown on the display. Push [SHIFT] [OVP RESET] keys can clear the OVP status and restore to the previous state.

- **Over Current Protection Setting**

The lighted OCP LED means the output current has exceeded the current setting value. At this moment, the instrument will stop, and get into OCP mode automatically; "OCP Err" will also show up on the display. It will restore to the previous state in a few second.

6-3. Voltage / Current Step Setting

- **Voltage Step (V STEP) Setting**

Push [STEP] key once or twice until the current meter displays V step function, then press [Number keys] and [↵] key to input step voltage.

Example : Set step voltage to 1.00V.

Push [STEP] once or twice until the current meter displays V step function, then press [1] [.] [0] [0] [↵].

- **Current Step (I STEP) Setting**

Push [STEP] Key once or twice until the current meter displays I step function, then press [Number keys] and [↵] key to input step current.

Example : Set step current to 0.01A.

Push [STEP] once or twice until the current meter displays I step function, then press [0] [.] [0] [1] [↵].

When you press [STEP] key, the display will indicate whether the instrument is in " V STEP mode " or " I STEP mode ". Once voltage and current STEP have been set, you can use [V↑], [V↓], [I↑], or [I↓] keys to select the step-up or step-down output voltage / current ranges.

6.4 Data Storage and Recall Setting

- **Data Storage Setting**

Push [SHIFT] [STORE] [Number keys] [↵].

Example : Set output voltage 10V, output current 1.0A, location 1.

- ① Push [V SET] [1] [0] [↵].
- ② Push [I SET] [1] [.] [0] [↵].
- ③ Push [SHIFT] [STORE] [1] [↵].

- **Data Recall Setting**

Push [SHIFT] [RECALL] [Number keys] [↵].

Example : Recall all the data in location 1.

You can Push [SHIFT] [RECALL] [1] [↵].

↳ " 1.000A " and " 10.00V " will be shown on the displays.

The stored data may also be recalled by pressing [RCL↑] or [RCL↓] keys.

6.5 Automatic Execution

- **Delay Setting**

Push [DLY] [Number keys] for minute [.] [Number keys] for second [↵].

Example : Set the delay to be 1 minute 10 seconds, and save it in location 1.

① Push [DLY] [1] [.] [1] [0] [↵].

② Push [SHIFT] [STORE] [1] [↵].

- **Auto-Execution**

Push [SHIFT] [RECALL] [Number for starting group] [.] [Number for ending group] [.] [Number for repetition] [↵].

Example : Execute from group 1 to group 5 for 3 times.

① Push [SHIFT] [RECALL] [1] [.] [5] [.] [3] [↵].

② Then Push [AUTO ON] and [OUTPUT ON] simultaneously to execute.

6.6 Serial Mode Operation (PPE-3323 only)

Push [SHIFT] [SERIAL].

↳ The Output Voltage will be $OUT1 + OUT2$, but the Output Current shall be $OUT1$.

Example : (1) $OUT 1$: Voltage = 10V, Current = 1A .

(2) $OUT 2$: Voltage = 20V, Current = 2A.

Push [SHIFT] [SERIAL] to change to Serial Mode .

↳ Output Voltage = 30V Output Current = 1A.

6.7 Track Mode Operation (PPE-3323 only)

Push [SHIFT] [TRACK].

To leave TRACK MODE, just push [SHIFT] [TRACK] again .

↳ The output voltage will be the value currently shown on the display.

Example : (1) $OUT 1$: Voltage = 10V, Current = 1A.

(2) $OUT 2$: Voltage = 20V, Current = 2A.

Suppose the instrument is in $OUT 2$ mode at present.

Push [SHIFT] [TRACK].

↳ Output voltage = $\pm 20V$, Output current = $\pm 2A$.

6.8 3.3V / 5V Output (PPE-3323 only)

Push [SHIFT] [3.3V / 5V].

Example : Push [SHIFT] [3.3V / 5V] once, then the output of OUT3 will be 3.3V. Push [SHIFT] [3.3V / 5V] again, then the output of OUT3 will be 5V.

6.9 PPE-1323/3323 Maximum Output Setting

| ITEM \ MODEL | PPE-1323 | PPE-3323 |
|-------------------------|-----------|-----------|
| Output Voltage | 33.00 V | |
| Output Current | 3.100 A | |
| Over Voltage Protection | 34.00 V | |
| Step Voltage | 10.00 V | |
| Step Current | 1.000 A | |
| Delay Time | 99'59" | |
| Memory | 99 groups | 49 groups |

7. Communication Interface

7.1 Operating with the Serial Transmission Commands :

(1) The serial transmission commands fall into three categories:

<1>. Value setting command such as "VSET1 12.00"

<2>. Controlling commands such as "OUT1"

<3>. Check commands such as "STATUS?"

(2) The format of a complete value setting command consists of "COMMAND" and "DATA", with more than one bit of space in between, e.g. COMMAND DATA.

◆◆◆◆◆◆◆◆◆◆◆◆◆◆◆◆
(THE WHOLE COMMAND)

(3) The user can place many commands in sequence at one time, and use "CR" or "LF" to be ending.

(4) The maximum length of a command group is 256 bytes, anything over 256 bytes will be ignored.

(5) Two complete commands should be separated by a semicolon ";" .

(6) As the command in a group are separated by “;”, the command will be stored in the buffer and be sent to PPE-3323/1323 local instrument via transmission line in order. One of the following messages may show on the value displays of PPE-3323/1323 in order to respond the command:

<1> “ DATA ERROR ” -----> The command is correct, but the data exceed certain rang.

<2> “ COMMAND ERROR ” > The value is correct, but the command is incorrect.

<3> When the “ OVP ERROR” message shows up on the instrument, it can only accept the “ reset OVP error command” and will respond with a “DISALLOW COMMAND” message to any other commands. This is to ensure that the user has placed the correction command to clear up the OVP of the system.

If any one of the commands is incorrect, the rest of the commands will not be carried out.

(7) The transmission format of RS-232 is as follows:

<1> 1 start bit.

<2> 8 bits for information.

<3> 1 ending bit.

<4> No parity.

<5> 2400BPS transmission Baud rate.

7.2 Table of Error Messages

| ERROR MESSAGE | PPE-3323 | PPE-1323 |
|-------------------------------------|----------|----------|
| OUTPUT 1 over-voltage protection | OVP ERR1 | OVP ERR |
| OUTPUT 2 over-voltage protection | OVP ERR2 | ----- |
| Serial mode over-voltage protection | OVP ERRS | ----- |
| Output over-current protection | OCP ERR | OCP ERR |
| OUTPUT 3 over-load protection | OUT3 OLP | ----- |
| Input data error | OVERRANG | OVERRANG |
| Data error | DATA ERR | DATA ERR |
| ROM error | ROM ERR | ROM ERR |
| RAM error | RAM ERR | RAM ERR |
| Calibration error | CALI ERR | CALI ERR |

7.3 RS-232C Serial Interface Commands

PPE-1323

| COMMAND | DESCRIPTION | EXAMPLE |
|---------|-----------------------------------|------------|
| OUT0 | OUTPUT OFF | ----- |
| OUT1 | OUTPUT ON | ----- |
| OCP0 | Disable over-current protection | ----- |
| OCP1 | Enable over-current protection | ----- |
| AUTO0 | Disable auto running | ----- |
| AUTO1 | Enable auto running | ----- |
| OVRST | Reset over-voltage protection | ----- |
| VSET | Set OUTPUT voltage value | VSET 32.00 |
| ISET | Set OUTPUT current value | ISET 3 |
| OVPSET | Set over-voltage protection value | OVPSET 34 |
| DELAY | Set delay time | DELAY 1.59 |
| STORE | Storage in memory address | STORE 99 |

| COMMAND | DESCRIPTION | EXAMPLE |
|---------|---|---------------------------|
| RECALL | Recall memory value Set auto running condition | RECALL 1 RECALL 0.99.3 |
| VSET? | Check OUTPUT voltage set value | ----- |
| ISET? | Check OUTPUT current set value | ----- |
| OVPSET? | Check over-voltage protection value | ----- |
| VOUT? | Check OUTPUT voltage value | ----- |
| IOUT? | Check OUTPUT current value | ----- |
| DELAY? | Check delay time | ----- |
| RECALL? | Check start end and count value | ----- |
| MEMORY? | Check memory of number | ----- |
| STATUS? | Check system status | ----- |

PPE-3323

| COMMAND | DESCRIPTION | EXAMPLE |
|----------------|--|----------------|
| CHAN1 | Select OUTPUT 1 | ----- |
| CHAN2 | Select OUTPUT 2 | ----- |
| VDD5 | Change OUT3 to 5V | ----- |
| VDD3.3 | Change OUT 3 to 3.3V | ----- |
| SERIAL | Change to serial mode | ----- |
| OUT0 | OUTPUT OFF | ----- |
| OUT1 | OUTPUT ON | ----- |
| OCP0 | Disable over-current protection | ----- |
| OCP1 | Enable over-current protection | ----- |
| AUTO0 | Disable auto-running | ----- |
| AUTO1 | Enable auto-running | ----- |
| TRACK0 | Disable TRACK mode | ----- |
| TRACK1 | Enable TRACK mode , OUTPUT 1 is master | ----- |
| TRACK2 | Enable TRACK mode , OUTPUT 2 is master | ----- |

| COMMAND | DESCRIPTION | EXAMPLE |
|----------------|---|---------------------------|
| OVPRST | Reset over-voltage protection | ----- |
| VSET1 | Change to OUTPUT 1 and set voltage value | VSET1 12.34 |
| VSET2 | Change to OUTPUT 2 and set voltage value | VSET2 32.00 |
| VSETS | Set serial mode OUTPUT voltage value | VSETS 64.00 |
| ISET1 | Change to OUTPUT 1 and set current value | ISET1 1.234 |
| ISET2 | Change to OUTPUT 2 and set current value | ISET2 2.456 |
| ISETS | Set serial mode OUTPUT current value | ISETS 3.000 |
| OVPSET1 | Set OUTPUT 1 over-voltage protection value | OVPSET1 34 |
| OVPSET2 | Set OUTPUT 2 over-voltage protection value | OVPSET2 34 |
| OVPSETS | Set serial mode over-voltage protection value | OVPSETS 68 |
| DELAY | Set delay time | DELAY 0.1 |
| STORE | Storage in memory address | STORE 1 |
| RECALL | Recall memory value Set auto running condition | RECALL 1 RECALL 0.49.3 |
| VSET1? | Check OUTPUT 1 voltage set value | ----- |

| COMMAND | DESCRIPTION | EXAMPLE |
|----------------|---|----------------|
| VSET2? | Check OUTPUT2 voltage set value | ----- |
| VSETS? | Check serial mode voltage set value | ----- |
| ISSET1? | Check OUTPUT 1 current value | ----- |
| ISSET2? | Check OUTPUT 2 current value | ----- |
| ISSETS? | Check serial mode current value | ----- |
| OVPSET1? | Check OUTPUT1 over-voltage protection value | ----- |
| OVPSET2? | Check OUTPUT2 over-voltage protection value | ----- |
| OVPSETS? | Check serial mode over-voltage protection value | ----- |
| VOUT1? | Check OUTPUT 1 voltage value | ----- |
| VOUT2? | Check OUTPUT 2 voltage value | ----- |
| IOUT1? | Check OUTPUT 1 current value | ----- |
| IOUT2? | Check OUTPUT 2 current value | ----- |
| DELAY? | Check delay time | ----- |
| RECALL? | Check start end and count value | ----- |
| MEMORY? | Check memory of number | ----- |
| STATUS? | Check system status | ----- |

7.4 System Status

| BIT | CONTROL LAMP (PPE-3323) | CONTROL LAMP (PPE-1323) |
|--------|------------------------------|------------------------------|
| BIT 12 | RMT | ----- |
| BIT 11 | OCP | ----- |
| BIT 10 | TRACK | ----- |
| BIT 9 | AUTO | ----- |
| BIT 8 | OUT | ----- |
| BIT 7 | SHIFT | ----- |
| BIT 6 | CH1 | RMT |
| BIT 5 | CH2 | OCP |
| BIT 4 | SERIAL | AUTO |
| BIT 3 | CC | OUT |
| BIT 2 | 3.3V | SHIFT |
| BIT 1 | 5V | CC |
| BIT 0 | CV | CV |

Example : PPE-3323

| | MSB | | | | | | | | | | | | | | | | | LSB |
|-----------------------------|--------|---|---|---|---|---|---|---|---|---|---|---|---|---|---|---|---|-------|
| | BIT 12 | | | | | | | | | | | | | | | | | BIT 0 |
| RMT, OUTPUT ON, CH1, 5V, CV | → | 1 | 0 | 0 | 0 | 1 | 0 | 1 | 0 | 0 | 0 | 0 | 0 | 0 | 0 | 0 | 1 | 1 |

Example : PPE-1323

| | MSB | | | | | | | LSB |
|--------------------------|-------|---|---|---|---|---|---|-------|
| | BIT 6 | | | | | | | BIT 0 |
| RMT, AUTO, OUTPUT ON, CV | → | 1 | 0 | 1 | 1 | 0 | 0 | 1 |

7.5 Programming of PPE-1323/3323

1. Single Command Syntax

<1> VSET 12.00 /* for PPE-1323 */
<2> OUT1
<3> ISET1? /* for PPE-3323 */

2. Multiple Command Syntax:

<1> VSET 2.00;ISET 2.00;OUT1 /* for PPE-1323 */
<2> VSET1 12.00;ISET1 2.00;OUT1 /* for PPE-3323 */

Note 1: The commands are different between PPE1323 and PPE3323. Please **DO NOT** mix using these commands.

Note 2: Please use the "CR" or "LF" or both as the code of ending in the end of each complete command set.

Note 3: For the multiple commands, please use semi-colon ";" to separate each command and no space between each command.

3. Program Examples by Using QBasic

```
OPEN "COM1:2400,N,8,1,CD0,CS0,DS0,OP0" FOR RANDOM AS #1 /* set up COM 1 as output port,  
                                                         baud rate=2400BPS */  
  
PRINT "PPE1323/PPE3323 TEST PROGRAM"  
  
PRINT #1, "vset1 15" /* set up PPE-3323 output  
                       voltage as 15 V */  
  
CLOSE #1 /* close the output of COM1 */  
  
END
```

8. Adjustment and Calibration

PPE-1323

| No. | Item | SPECS. | Conditions | Component | Adj. Spec. | Remark |
|-----|----------------------------|----------------------------------|---|-----------|------------|--------|
| 1 | Preparation | | <ul style="list-style-type: none"> ① Pre-heat 30 Min or more. ② Ambient temperature $23\pm 5^{\circ}\text{C}$, humidity under PH80%. | | | |
| 2 | Check on Operating Voltage | $\pm 15\text{V}\pm 0.75\text{V}$ | <ul style="list-style-type: none"> ① Turn on the power ② Use DMM to test and ensure that <ul style="list-style-type: none"> → J307 PIN-8 and U313 PIN-2 are both +15V. → J307 PIN-10 and U314 PIN-1 are both -15V. | | Confirm | |
| | | $+5\text{V}\pm 0.25\text{V}$ | <ul style="list-style-type: none"> ① Turn on the power ② Use DMM to test and ensure that <ul style="list-style-type: none"> → the cases of U115 PIN-3 and U115 are +5V. → the cases of U116 PIN-3 and U116 are +5V. → the cases of U209 PIN-3 and U209 are +5V. | | Confirm | |

| No. | Item | SPECS. | Conditions | Component | Adj. Spec. | Remark |
|-----|----------------------------|-----------|---|-----------|---------------------|--------|
| 3 | Output Voltage Calibration | | <ul style="list-style-type: none"> ① Push [SHIFT] [↵] [3001] [↵]. ↳ the MEMORY display will show "01", and A display will show "CL01". ② Use DMM at DC 200V, to measure the value at output terminal. ③ Key in the measured value. ④ Push [↵], and continue the next step. | | 31V 34V | |
| | | 0 ~ 400mV | When the MEMORY display shows "02", <ul style="list-style-type: none"> ① Set DMM at DC 2V to measure the value at output terminal. ② Key in the measured value. ③ Push [↵]. | | 200mV 400mV | |
| 4 | Output Current Calibration | | <ul style="list-style-type: none"> ① Push [SHIFT] [↵] [3002] [↵]. ↳ the MEMORY display will show "01", and A display will show "CL02". ② Use DMM at DC 20A, to measure the value at output terminal. ③ Key in the measured value. ④ Push [↵], and continue the next step. | | 2.9A 3.2A | |
| | | 0 ~ 100mA | When the MEMORY display shows "02", <ul style="list-style-type: none"> ① Set DMM at DC 2A to measure the value at output terminal. ② Key in the measured value. ③ Push [↵]. | | 50mA 100mA | |

PPE-3323

| No. | Item | SPECS. | Conditions | Component | Adj. Spec. | Remark |
|-----|----------------------------|---------------------|--|-----------|------------|--------|
| 2 | Check on operating voltage | $\pm 15V \pm 0.75V$ | <ul style="list-style-type: none"> ① Turn on the power ② Use DMM to test and ensure that → J307 PIN-8 and U313 PIN-2 are both +15V. → J307 PIN-10 and U314 PIN-1 are both -15V. | | Confirm | |
| | | $+5V \pm 0.25V$ | <ul style="list-style-type: none"> ① Turn on the power ② Use DMM to test and ensure that → the cases of U115 PIN-3 and U115 are +5V. → the cases of U116 PIN-3 and U116 are +5V. → the cases of U209 PIN-3 and U209 are +5V. → the cases of U105 PIN-4 and U105 are +5V. | | Confirm | |

| No. | Item | SPECS. | Conditions | Component | Adj. Spec. | Remark |
|-----|------------------------------------|-----------|---|-----------|---------------------|--------|
| 3 | OUTPUT 1 Voltage Calibration | | <ul style="list-style-type: none"> ① Push [SHIFT] [↵] [3001] [↵]. ↳ the MEMORY display will show "01", and A display will show "CL01". ② Use DMM at DC 200V to measure the value at OUTPUT 1. ③ Key in the measured value. ④ Push [↵], and continue the next step. | | 31V 34V | |
| | | 0 ~ 400mV | When the MEMORY display shows "02", <ul style="list-style-type: none"> ① Set DMM at DC 2V to measure the value at output terminal. ② Key in the measured value. ③ Push [↵]. | | 200mV 400mV | |
| 4 | OUTPUT 2 Voltage Calibration | | <ul style="list-style-type: none"> ① Push [SHIFT] [↵] [3002] [↵]. ↳ the MEMORY display will show "01", and A display will show "CL02". ② Use DMM at DC 200V, to measure the value at OUTPUT 2. ③ Key in the measured value. ④ Push [↵], and continue the next step. | | 31V 34V | |
| | | 0 ~ 400mV | When the MEMORY display shows "02", <ul style="list-style-type: none"> ① Set DMM at DC 2V to measure the value at OUTPUT 2. ② Key in the measured value. ③ Push [↵]. | | 200mV 400mV | |

| No. | Item | SPECS. | Conditions | Component | Adj. Spec. | Remark |
|-----|------------------------------------|-----------|--|-----------|--------------------|--------|
| 5 | OUTPUT 1 Current Calibration | | <ul style="list-style-type: none"> ① Push [SHIFT] [↵] [3003] [↵]. ↳ the MEMORY display will show "01", and A display will show "CL03". ② Use DMM at DC 20A to measure the value at OUTPUT 1. ③ Key in the measured value. ④ Push [↵], and continue the next step. | | 2.9A 3.2A | |
| | | 0 ~ 100mA | When the MEMORY display shows "02", <ul style="list-style-type: none"> ① Set DMM at DC 2A to measure the value at output terminal. ② Key in the measured value. ③ Push [↵]. | | 50mA 100mA | |
| 6 | OUTPUT 2 Current Calibration | | <ul style="list-style-type: none"> ① Push [SHIFT] [↵] [3004] [↵]. ↳ the MEMORY display will show "01", and A display will show "CL04". ② Use DMM at DC 20A, to measure the value at OUTPUT 2. ③ Key in the measured value. ④ Push [↵], and continue the next step. | | 2.9A 3.2A | |
| | | 0 ~ 100mA | When the MEMORY display shows "02", <ul style="list-style-type: none"> ① Set DMM at DC 2A to measure the value at output terminal. ② Key in the measured value. ③ Push [↵]. | | 50mA 100mA | |

| No. | Item | SPECS. | Conditions | Component | Adj. Spec. | Remark |
|-----|-----------------------------------|---------------------|--|-----------|------------|--------|
| 7 | OUTPUT 3 5V/3.3V Adjustment | | <ul style="list-style-type: none"> ① Push [SHIFT] [3.3V/5V] to shift to 5V. ② Set DMM at DC 20V to measure the value at OUTPUT 3. ③ Adjust "VR401" until the readout in DMM to be 5V. | VR 401 | 5V±0.25V | |
| 8 | OUTPUT 3 3.3V Confirmation | 3.3V±0.16 | <ul style="list-style-type: none"> ① Push [SHIFT] [3.3V/5V] to shift to 3.3V ② Set DMM at DC 20V to measure OUTPUT3 | | Confirm | |
| 9 | OUTPUT 3 OLP Confirmation | 5V±0.25V >3A | <ul style="list-style-type: none"> ① Set DMM at DC 20V to measure the value at OUTPUT 3. ② Push [OUTPUT ON], be sure the output is 5V. ③ Connect a around 1.5Ω, make sure that the output current is ≥3.1A. ⚡ "OUT 3 OLP" should appear in the display on the front panel. | | Confirm | |

9. The System Diagram and Description

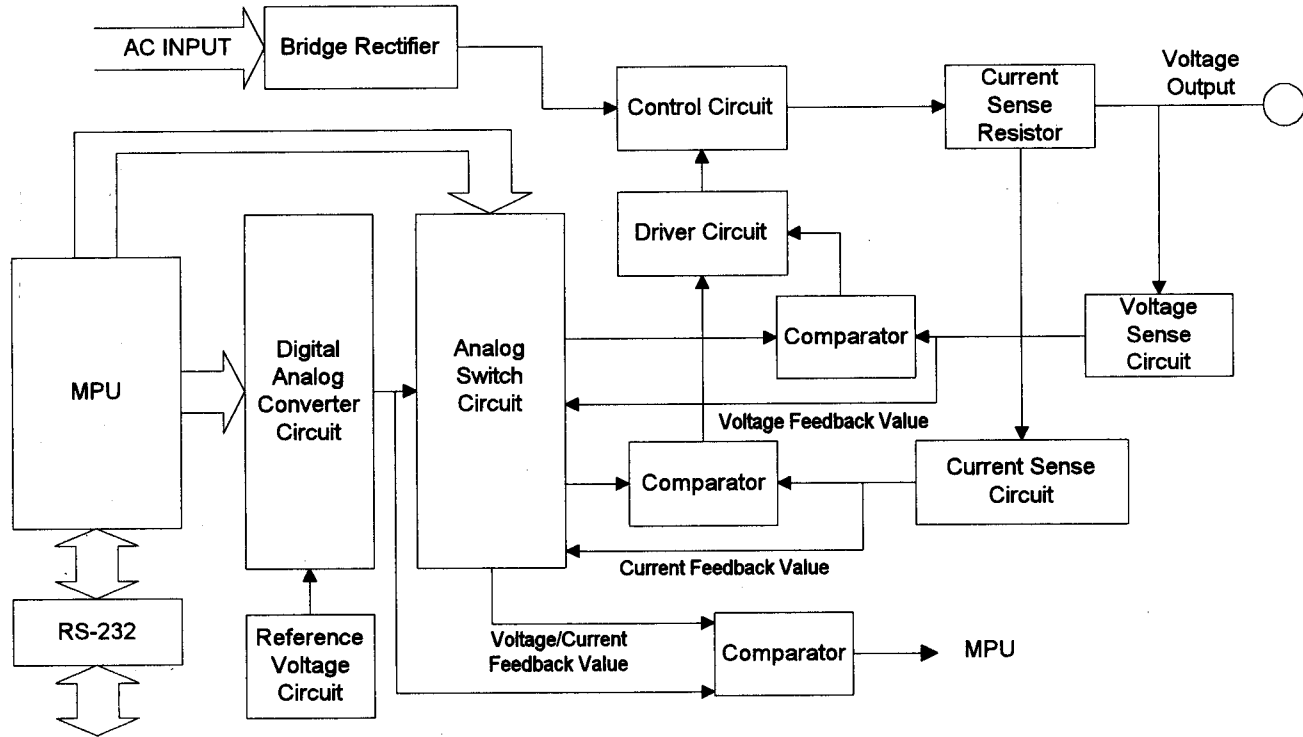

The graph on last page is the system diagram of PPE-1323/3323, which consists of micro processor unit (MPU), digital to analog converter (DAC), analog switch circuit, reference voltage circuit, driver circuit, control circuit, current sense resistor, current sense circuit, voltage sense circuit, comparator. etc. The main components of each block are list below:

| | |
|---------------------------|--|
| DAC | : U309 AD7541, U308 LM741 |
| Analog switch circuit | : U305 CD4051B, U306 CD4052B |
| Reference voltage circuit | : U310 TL431, U311 LM741 |
| Driver circuit | : Q301 2SC1815, Q305 2SD880, Q401 2SA1015, Q408 2SB507 |
| Voltage control circuit | : Power transistor MJ15015, MJ15016 |
| Current sense resistor | : R351 / R352 / R405 / R406 0.3 Ω / 5W |
| Current sense circuit | : U301 / U401 OP07 (differential amplifier) |
| Voltage sense circuit | : R329 / R410 30.1KF, R328 / R411 4.99KF |

The operation of the whole circuitry is stayed as follows:

The reference voltage circuit, U310 TL431 PIN-1, outputs voltage at around 2.5V, which will be amplified to $5.76V^{*1}$ by a non-inverter amplifier, U311 LM741 PIN-6. The amplified voltage will then be treated as the reference voltage to DAC U309 AD7541. Since AD7541 is a 12-bit DAC, the resolution is $1.4mV/bit^{*2}$.

C.V. Mode

When the instrument is in C.V. Mode, the MPU will send 3300 Counts, i.e., the output voltage is 33.00V, to DAC, and the voltage in U308 LM741 PIN-6 will be $-4.64V^{*3}$. This current will be output from the analog switch PIN-1, go through the Sample Hold circuit (R327, C309, and Buffer circuit U304 TL072), then be output again from U304 PIN-7 to U303 LM301 PIN-2 of the comparator. Here, the voltage will be compared with the real output voltage value, which is retrieved by the voltage sense circuit, from PIN-3. As the entire circuit is a close loop, the voltage in U303 PIN-2 and PIN-3 should be the same, and there will be a relative voltage value from the output PIN-6 to energize diode D304, and to disconnect D303. This relative voltage will then get through a driver circuit to manage the whole control circuit, and to generate the required output voltage. Since the attenuation of the voltage sense circuit is 0.142^{*4} , the output voltage is $32.68V^{*5}$. If the output is 10V, the voltage of U303 PIN-2 and PIN-3 will be $1.42V^{*6}$.

^{*1} $2.5(1+R340/R341)=2.5(1+4.99K/3.83K)=5.76V$

^{*2} $5.76V/4095 = 1.4mV/bit$

^{*3} $-1.4mV \times 3300 = -4.64V$

^{*4} $A=R328/(R328+R329) = 4.99K/(4.99K+30.1K)=0.142$

^{*5} $V_{out}=4.64V/A=4.64/0.142 = 32.68V$

C.C. Mode

The operation in C.C. Mode is similar to that in C.V. Mode. The MPU will send 3100 Counts, i.e. 3.1A output current, to DAC, and the current in U308 PIN-6 will be $-4.34V^{*7}$. This current will be output from the analog-switch PIN-5, and go through the Sample Hold circuit (R317, C308 and Buffer circuit U304 TL072). The U304 PIN-1 will then output $-4.34V$ current to U302 LM301 PIN-2 of the comparator. Here, the voltage will be compared with the real output voltage value, which is retrieved by the current sense circuit, from PIN-3. As the entire circuit is a close loop, the voltage from PIN-2 and PIN-3 should be the same, and there will be a relative voltage value from the output PIN-6 of U302 to energize diode D303, and to disconnect D304. This relative voltage will then get through a driver circuit to manage the whole control circuit, and to generate the required output voltage.

The main component in the current sense circuit is differential amplifier U301 OP07. With magnifying power of -9.53^{*8} , it can gauge the voltage value from current sense resistor. As the voltage from PIN-2 and PIN-3 of U302 should be the same, the voltage on the both sides of current sense resistor is $0.455V^{*9}$, and the output current is $3.04A^{*10}$. If the output current is 1A, the voltage from U302 PIN-2 and PIN-3 will be around $-1.43V^{*11}$.

$*6 \text{ Vout} \times A = 10 \times 0.142 = 1.42V$

$*7 -1.4mV \times 3100 = -4.34V$

$*8 A = -R302/R305 = -18.2K/1.91K = -9.53$

$*9 \text{ voltage} = -4.34/-9.53 = 0.455V$

$*10 \text{ Iout} = (0.455/R352) \times 2 = 3.04A$

$*11 -(Iout \times 0.3\Omega/2) \times 9.53 = -(1 \times 0.3/2) \times 9.53 = -1.43V$

The processes of generating the displayed value of voltage and current are stated below:

The voltage / current sense circuit retrieves a voltage value, which will go through an analog switch, U306 CD4052 PIN-3, then to U307 PIN-3 of the comparator to be compared with the voltage value from DAC. Since the instrument treats the D/A converter as an A/D converter, when U307 changes state, the voltage from DAC will be the real output value of the instrument, i.e. the displayed value.

The difference between C.V. Mode C.C. Mode

In C.V. Mode, U302 PIN-6 is at the Hi level ($\approx 13.6V$); the current goes through D302, then be sent to MPU after being divided by R318 and R319 ($13.6 \times R319 / (R318 + R319) = 13.6 \times 2.2 / (4.7 + 2.2) \approx 4.33V$). In C.C. Mode, U302 PIN-6 is at the Low level, and the current is sent to MPU after being divided by R318 and R319.

The operation of the circuitry of PPE-3323 is similar to that of PPE-1323, the difference is the former has Slave output and 3.3/5V output functions.

RS232 (9Pin Male or 25Pin Female)

The equipment is a DTE device with a 9-pin or 25-pin D-type shell RS-232 connector located on the rear panel. Figure 1 & 3 show the equipment of 9-pin connector(male) and 25-pin connector(female) with its pin number assignments. When connecting the equipment to another RS-232 device, please consider the following suggestions:

- Many devices require a constant high signal on one or more input pins.
- Do not connect the output line of one DTE device to the output line of the other.
- Ensure that the signal ground of the equipment is connected to the signal ground of the external device.
- Ensure that the chassis ground of the equipment is connected to the chassis ground of the external device.

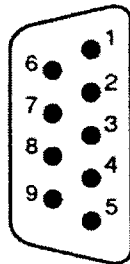

9-PIN D-SHELL

1. No connection
2. Transmit Data (TxD) (output)
3. Receive Data (RxD) (input)
4. No connection
5. Signal Ground (GND)
6. No connection
7. No connection
8. No connection
9. No connection

Figure 1: Pin Assignments of the RS-232 Connector on the rear panel for DB-9-D Connector

DB9 to DB9

This wiring configuration is used for computers with DB-9-D connectors configured as Data Terminal Equipment.

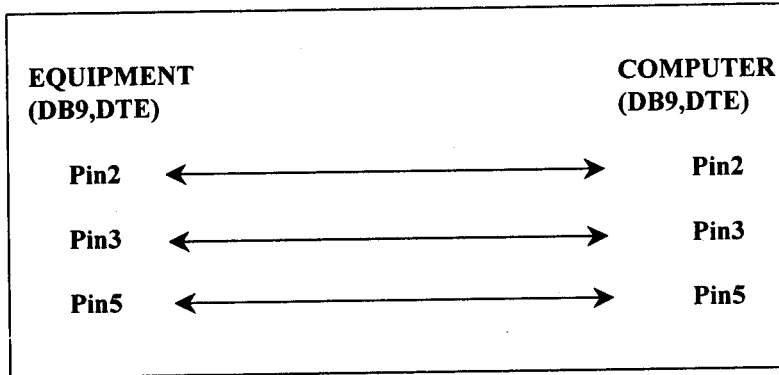
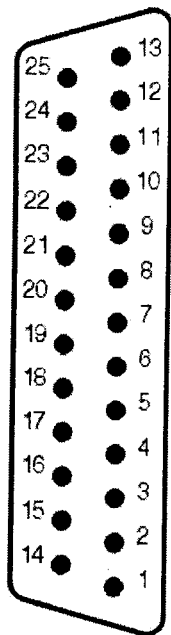

Figure 2: Wiring Configuration for DB9 TO DB9



25-PIN D-SHELL

1. No Connection
2. Receive Data (RxD) (input)
3. Transmit Data (TxD) (output)
4. No connection
5. No connection
6. No connection
7. Signal Ground (GND)
8. No connection
9. No connection
10. No connection
11. No connection
12. No connection
13. No connection
14. No connection
15. No connection
16. No connection
17. No connection
18. No connection
19. No connection
20. No connection
21. No connection
22. No connection
23. No connection
24. No connection
25. No connection

Figure 3: Pin Assignments of the RS-232 Connector on the rear panel for DB-25-D Connector

DB25 to DB25 & DB25 to DB9

The wiring configurations below are used for computers with DB-25-D and DB-9-D connectors configured as Data Terminal Equipment.

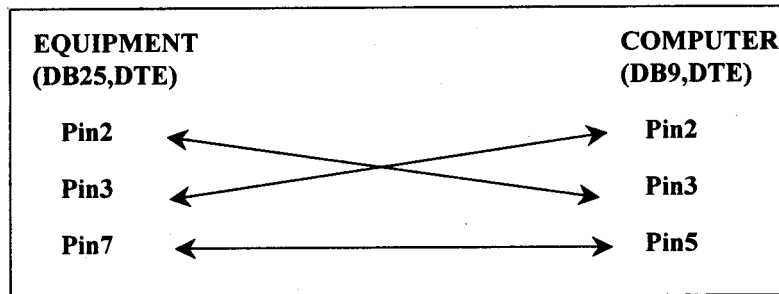
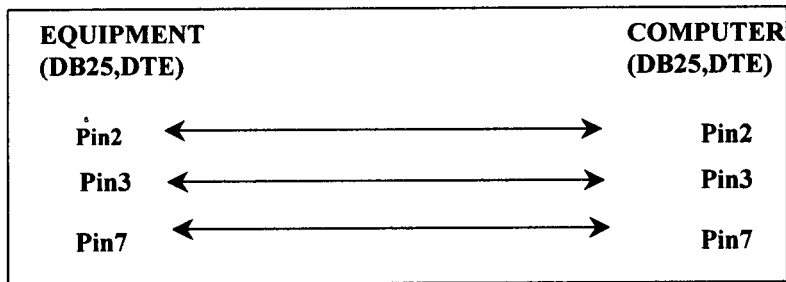

Figure 4: Wiring Configuration for DB25 to DB25 & DB25 to DB9